

<https://www.nazme.co.jp>

高度管理医療機器等販売業貸与業許可番号 2022文文生業第1974号
第三種医療機器製造販売業許可番号 13B3X00413号

 株式会社 夏目製作所
<https://www.nazme.co.jp>

2-18-6, Yushima, Bunkyo-ku, Tokyo JAPAN 113-8551
contact : g-support@nazme.co.jp

3

Surgical and Dissection Instruments



株式会社 夏目製作所
NATSUME SEISAKUSHO CO.,LTD.

CONTENTS

2024.3 Ver.13_E

A	Tweezers	2~5
B	Scissors	6~15
C	Forceps·Needle holders	16~20
D	Blades	21~22
E	Set	23~28
F	Retractor others	29~30
H·I·J·K	Related Items	30~30
KN	Laryngoscopes	32~33
MA	Micro tweezers	33~35
MB	Micro scissors	36~37
MC~MF	Micro others	38~39

A-1 Tweezers straight type without hook
 Stainless steel
 Full length: 130mm, 200mm, 250mm, 300mm



Groove cut on the tip for better gripping.

A-2 Hooked tweezers straight type
 Stainless steel
 Full length: 130mm, 180mm, 200mm

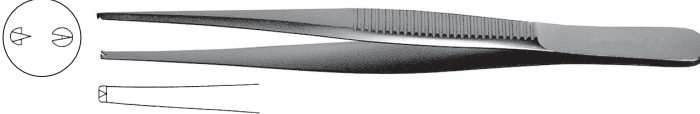

Hook on the tip as shown in the figure.

A-3-1 Tapered tweezers straight type
 Stainless steel
 Full length: 130mm, 180mm, 230mm



Tapered and grooved for better gripping.

A-3-2 Tweezers bent tip tapered type without hook
 Stainless steel
 Full length: 130mm

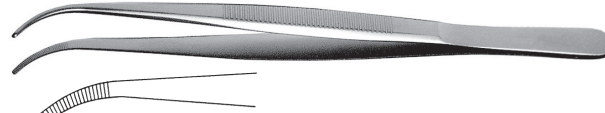

Tapered, curved, grooved for better gripping.

A-4-1 Hooked tapered tweezers straight type
 Stainless steel
 Full length: 130mm, 180mm

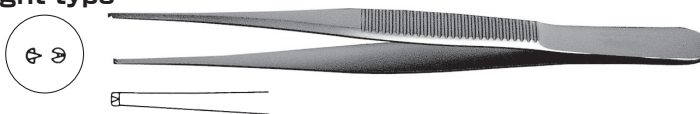

Tapered, hook on the tip as shown in the figure.

A-4-2 Hooked tweezers bent tip
 Stainless steel
 Full length: 130mm

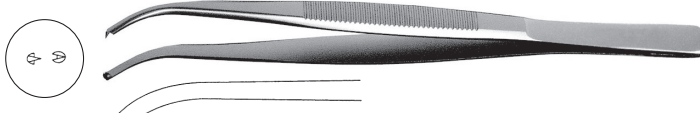

Tapered, curved, hook on the tip as shown in the figure.

A-5 Tapered tweezers straight type without hook
 Stainless steel
 Full length: 110mm

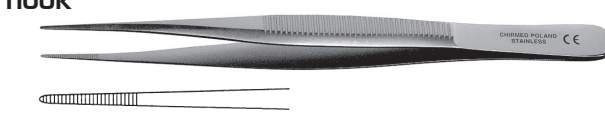

Tapered and grooved for better gripping.

A-6 Hooked tapered tweezers straight type
 Stainless steel
 Full length: 110mm

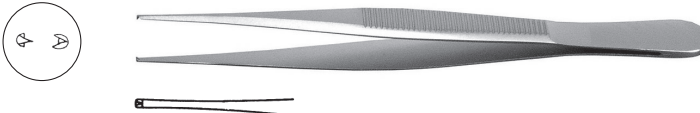

Tapered, hook on the tip as shown in the figure.

A-7 Iris tweezers straight type without hook
 Stainless steel
 Full length: 100mm

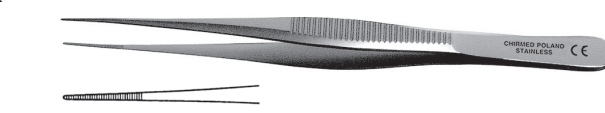

Tapered and grooved for better gripping.

A-8 Hooked Iris tweezers straight type
 Stainless steel
 Full length: 100mm

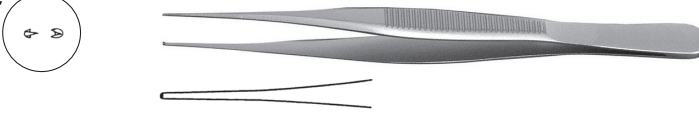

Tapered, hook on the tip.

A-9 Tweezers bent tip tapered type without hook
 Stainless steel
 Full length: 125mm
 Bent end: 14mm

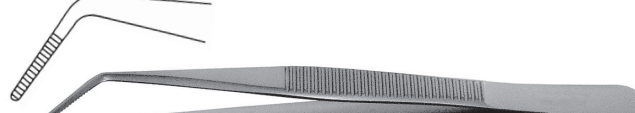

A-10 Hooked tweezers bent tip tapered type
 Stainless steel
 Full length: 125mm
 Bent end: 14mm

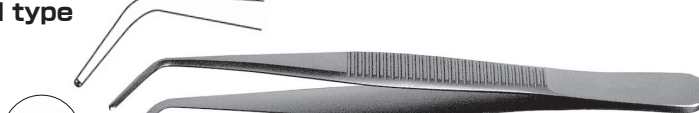

Angled downwards, hook on the tip as shown in the figure.

A-11 Tweezers bent tip tapered type without hook
 Stainless steel
 Full length: 120mm
 Bent end: 20mm



Grooved for better gripping.

A-12-1 Tweezers bent tip tapered type without hook
 Stainless steel
 Full length: 110mm



Curved, grooved for better gripping.

A-12-2 Tweezers bent tip tapered type without hook
 Stainless steel
 Full length: 100mm
 w/ Notch



Grooved for better gripping. Notch on the body to prevent the tip from shifting when it is clamped.

A-12-3 Tweezers bent tip tapered type without hook
 Stainless steel
 Full length: 115mm
 w/ Notch



Tip is about 1.2 mm wide, flat surface without a groove. Notch on the body to prevent the tip from shifting when it is clamped.

A-13 Hooked tweezers bent tip tapered type
 Stainless steel
 Full length: 105mm

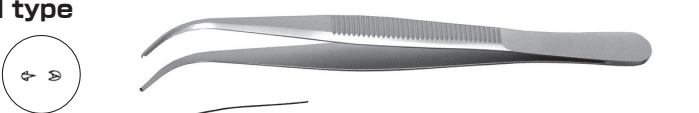

Hook is attached to the tip as shown in the figure.

A-14 Tweezers bent tip tapered iris type without hook
 Stainless steel
 Full length: 100mm



Grooved for better gripping.

A-15 Hooked tweezers bent tip tapered iris type
 Stainless steel
 Full length: 100mm



Curved, hook on the tip as shown in the figure.

A-16 Tweezers sharp type
 Stainless steel
 Full length: 140mm



A-17 Tweezers sharp type
 Stainless steel
 Full length: 130mm



A-18 Tweezers sharp type
 Stainless steel
 Full length: 110mm



A-19 Tweezers sharp type
 Stainless steel
 Full length: 100mm



A-20 Engineering tweezers
 Stainless steel
 Full length: 115mm



Thin, sharp without grooves.

A-21 Spine removal tweezers
 Stainless steel
 Full length: 115mm



A-22 Sprinter tweezers
 Stainless steel
 Full length: 120mm



A-23 Bent tweezers (dental pins)
 Stainless steel
 Full length: 160mm
 Bent end: 15mm



Angled downwards, without grooves.

A-24 Geniculate tweezers rooteppin type
 Stainless steel
 Full length: 140mm Bent end: 55mm
 Full length: 170mm Bent end: 80mm



Geniculate tweezers. Grooved for better gripping.

A-25 Bent tweezers
 Stainless steel
 Full length: 100mm
 Bent end: 50mm



Grooved for better gripping.

A-26 Ring tipped tweezers
 Stainless steel
 Full length: 100mm
 Ring outer diameter: approx. ϕ 3mm



Suitable for spherical objects or objects that you do not want to scratch.

A-27 Ring tipped tweezers
 Stainless steel
 Full length: 100mm
 Ring outer diameter: approx. ϕ 6mm



A-38 Ring tipped tweezers
 Stainless steel
 Full length: 105mm
 Ring outer diameter: approx. ϕ 11mm
 W/ Notch



Suitable for spherical objects or objects that you do not want to scratch.

A-28 Ring tipped tweezers
 Stainless steel
 Full length: 100mm
 Ring outer diameter: approx. ϕ 6 \times 8mm



A-29 Ring tipped tweezers
 Stainless steel
 Full length: 100mm
 Ring outer diameter: approx. ϕ 8 \times 10mm



Suitable for spherical objects or objects that you do not want to scratch.

A-32 Geniculate sharp spoon tweezers
 Stainless steel
 Full length: 200mm
 Spoon diameter: ϕ 7mm



Cup-shaped tip.

A-33 Sharp spoon tweezers straight type
 Stainless steel
 Full length: 150mm
 Spoon diameter: ϕ 5mm



Cup-shaped tip.

A-37 Deck tweezers curved type
 Stainless steel
 Full length: 110mm



Flat plate-like tip. Suitable for pinching thin film-like objects without damaging them.

Steel Instruments Specialized for Animal Experiment Procedures

<For small experimental animals>
<For the success of delicate experimental techniques>
<For the dexterous and small hands of Japanese researchers>

NAPOX®

In 1970, our pursuit of excellence in animal testing techniques led us to Poland, a communist country at the time, where we adopted sophisticated European technology for crafting high-quality medical steel instruments. Impressed by the exceptional quality, we didn't stop there. Recognizing a size mismatch with Japanese hands, we swiftly journeyed back to Poland, driving a series of enhancements that birthed the renowned NAPOX® series! This legendary brand, a favorite among researchers for years, is meticulously designed to accommodate the dexterity and reduced strength of Japanese hands compared to their Western counterparts. More than just a tool, the NAPOX® series is a precision masterpiece, the trusted choice for delicately handling small mice and ensuring precise techniques in research.



Make it Smooth ~Successful Smooth Procedure~

The lineup of scissors and other items in the NAPOX® series are reborn as Leprex. We strived to further improve the quality while keeping the familiar shape. It is characterized by its lightness of touch and sharpness, allowing you to proceed smoothly with surgeries and experimental procedures. Please feel free to use it for yourself to find out how easy it is to use for long periods of surgeries and experimental procedures, without getting tired, without losing its sharpness, and because it cuts quickly, stress-free and smooth to use.

* Some items are other than scissors.

Regarding the current transition and preparation status, we have identified each product by colored dot next to the dimensions.

● : Leprex products available ● : Leprex products in preparation
No Mark : Leprex products not applicable

※We will gradually transition from NAPOX to Leprex.
For the latest information, please visit our website or contact your sales representative.



B-1 Straight scissors both blunt
Stainless steel
Full length : 145mm ●, 165mm, 185mm ●

B-1-L Straight scissors both blunt left handed
Stainless steel
Full length : 145mm ●

B-2 Curved scissors both blunt(Cooper)
Stainless steel
Full length : 145mm ●

B-2-L Curved scissors both blunt(Cooper) left handed
Stainless steel
Full length : 145mm ●

B-3 Straight scissors sharp/blunt
Stainless steel
Full length : 145mm ●, 165mm ●, 185mm ●

LB-3-L Straight scissors sharp/blunt left handed
Stainless steel
Full length : 145mm ●

B-4 Curved scissors sharp/blunt
Stainless steel
Full length : 145mm ●

B-4-L Curved scissors sharp/blunt left handed
Stainless steel
Full length : 145mm ●

B-5 Straight scissors both sharp
Stainless steel
Full length : 145mm ●, 165mm ●, 185mm ●

B-5-L Straight scissors both sharp left handed
Stainless steel
Full length : 145mm ●

B-6 Curved scissors both sharp
Stainless steel
Full length : 145mm ●

B-6-L Curved scissors both sharp left handed
Stainless steel
Full length : 145mm ●

LB-7 Straight scissors sharp/spherical
Stainless steel
Full length : 130mm ●, 185mm

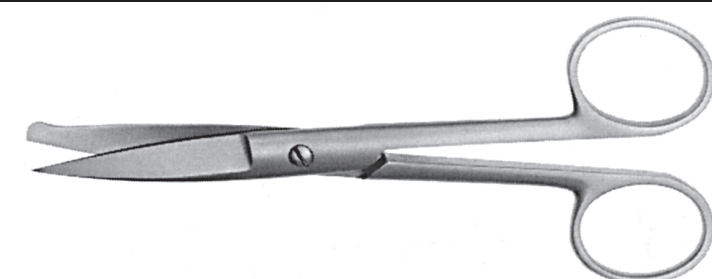
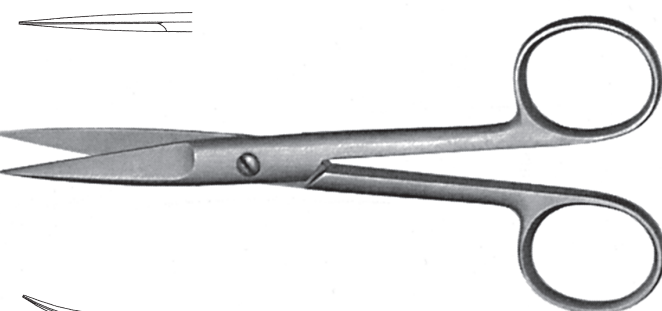
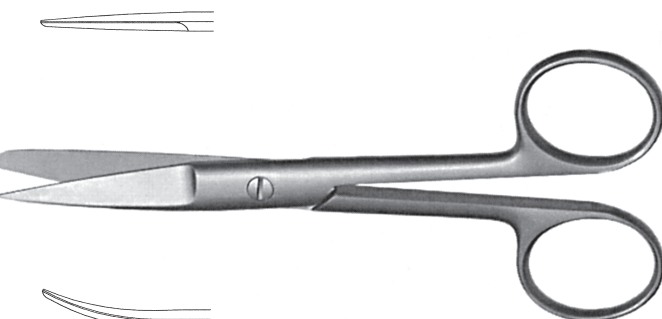
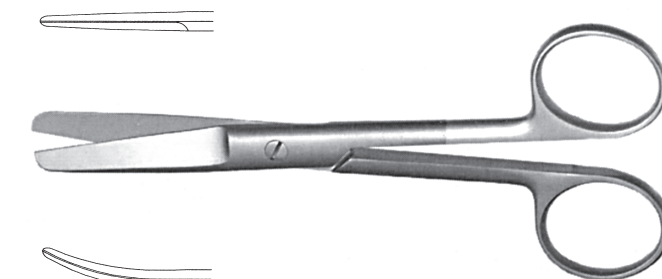

One side of the blade has a spherical edge to prevent tissue damage.

● : Leprex products available ● : Leprex products in preparation No Mark : Leprex products not applicable

B-8 Mayo straight scissors

Stainless steel
Full length: 140mm ●

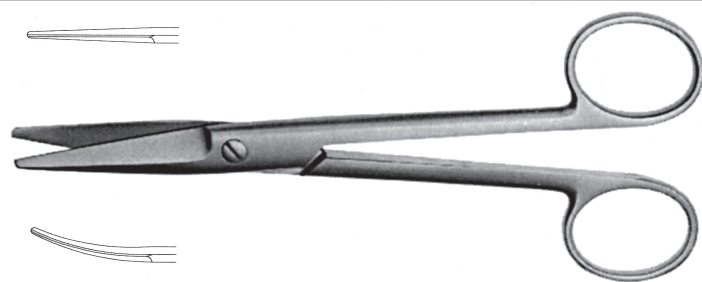

B-9 Mayo curved scissors

Stainless steel
Full length: 140mm ●, 170mm ●



One side is slightly longer, the tip is flattened and rounded.

B-10 Geniculat scissors

Stainless steel
Full length: 150mm ●



B-11 Straight scissors

Stainless steel
Full length: 185mm ●

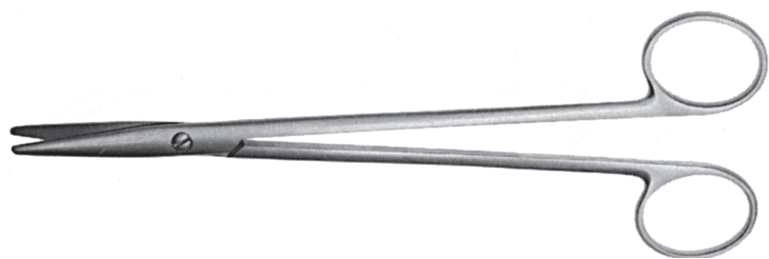

LB-12 Iris scissors both sharp

Stainless steel
Full length: 110mm ●

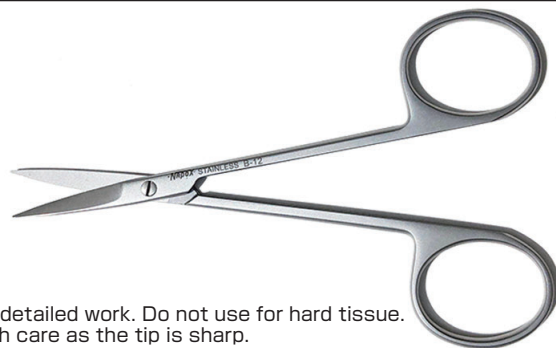

LB-12-L Iris scissors both sharp left handed

Stainless steel
Full length: 110mm ●



Suitable for detailed work. Do not use for hard tissue.
* Handle with care as the tip is sharp.

LB-12-2 Iris scissors both sharp short blade

Stainless steel
Full length: 98mm ●
Blade length: 12mm

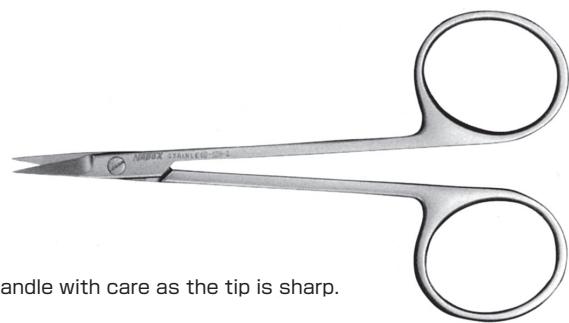

* Handle with care as the tip is sharp.

LB-12-S Iris scissors sharp/blunt

Stainless steel
Full length: 110mm ●



* Handle with care as the tip is sharp.

B-13 Iris scissors curved both sharp

Stainless steel
Full length: 110mm ●



B-13-L Iris scissors curved both sharp left handed

Stainless steel
Full length: 110mm ●

* Handle with care as the tip is sharp.

LB-14 Iris scissors both blunt

Stainless steel
Full length: 115mm ●



B-15 Iris scissors curved both blunt

Stainless steel
Full length: 115mm ●

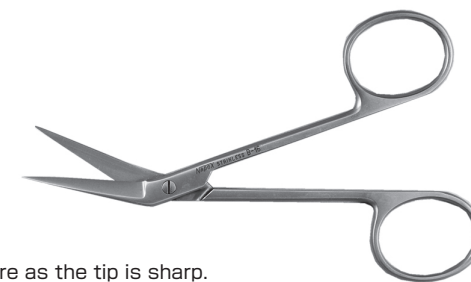

Angled.
* Handle with care as the tip is sharp.

B-16 Geniculat small scissors

Stainless steel
Full length: 115mm ●



LB-17 Golden crown straight scissors

Stainless steel
Full length: 120mm ●



B-18 Golden crown curved scissors

Stainless steel
Full length: 120mm ●

Short and sturdy, suitable for hard objects.

B-19 Nail Clipper

Stainless steel
Full length: 120mm



Diagonal cutting pliers-type for nail clipping.
Handle always returns to the open position with a plate spring.

B-20 Bone scissors straight type

Stainless steel
Full length: 155mm ●, 220mm



B-21 Bone scissors curved type

Stainless steel
Full length: 170mm ●, 220mm ●

Box type shaft transmits power in a well-balanced manner.
Plate spring ensures handle always returns to the open position.

B-22 Dissection scissors

Stainless steel
Full length: 235mm



Handle always returns to the open position by plate spring.

LB-23 Dissection small scissors both sharp straight type

Stainless steel
Full length: 130mm ●



B-24 Dissection small scissors both sharp curved type

Stainless steel
Full length: 130mm ●

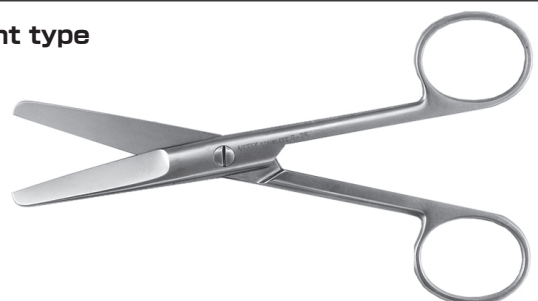

B-25 Dissection small scissors both blunt straight type

Stainless steel
Full length: 130mm ●



B-26 Dissection small scissors both blunt curved type

Stainless steel
Full length: 130mm ●

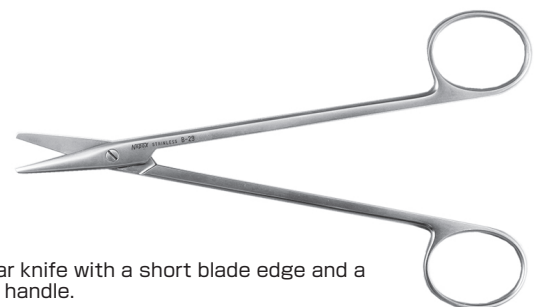

LB-27 Dissection small scissors sharp/blunt straight type

Stainless steel
Full length: 130mm ●

B-28 Dissection small scissors sharp/blunt curved type

Stainless steel
Full length: 130mm



B-29 Dissection scissors straight type

Stainless steel
Full length: 150mm ●

Shear knife with a short blade edge and a long handle.

B-30 Miscellaneous scissors

Stainless steel
Full length: 240mm

Large scissors for cutting gauze, bandages, etc.

B-31 Dissection slim scissors straight type

Stainless steel
Full length: 145mm ●, 160mm ●, 185mm



B-32 Dissection slim scissors curved type

Stainless steel
Full length: 145mm ●, 160mm ●, 185mm ●

B-33 Dissection scissors special damping blade

Stainless steel
Full length: 200mm ●



B-34 Curved scissors

Stainless steel
Full length: 160mm



Cutting edge of curved scissors remains horizontal when placed on a horizontal surface.

B-35 Rib scissors

Stainless steel
Full length: 190mm



B-36 Bone cutter with double action joint

Stainless steel
Full length: 155mm



Designed for hard objects using the lever principle. The tip of the blade always opens by spring.

B-37 Bone cutter with double action joint

Stainless steel
Full length: 270mm



B-38 Nail clipper sliding type

Sliding blade made of steel
Full length: 120mm



Sliding blade cuts off claws of dogs, cats, etc.
Do not use for flat claws of monkeys, etc.

LB-39 Hair shearing scissors S size

Stainless steel
Full length: 155mm ●



LB-40 Hair shearing scissors L size

Stainless steel
Full length: 170mm ●

Rounded blade tip to prevent damage to the animal and curved for easy trimming animal hair down to the root.

B-41 Angora hair shearing scissors

Stainless steel
Full length: 200mm



Lower blade is thickened to prevent damage to the animal skin.

B-44 Spherical tip scissors

Stainless steel
Full length: 110mm ●



Spherical tip to prevent tissue damage.

B-45 Scissors for deep areas S size

Stainless steel
Full length: 140mm
Insertion part: 80mm
Blade length: 5mm

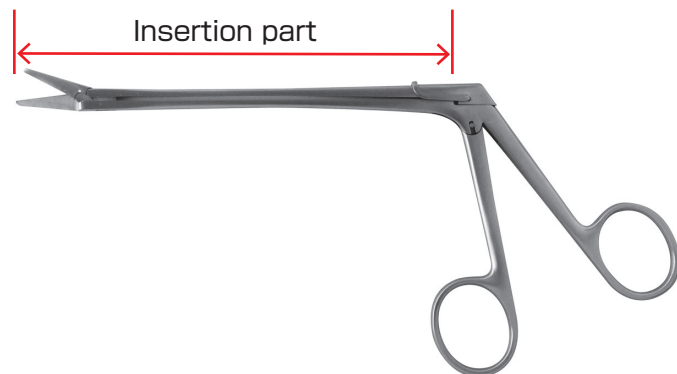

B-46 Scissors for deep areas L size

Stainless steel
Full length: 220mm
Insertion part: 152mm
Blade length: 20mm

Designed to allow cutting operations in the back of narrow spaces.

B-48 Curved small scissors both sharp

Stainless steel
Full length: 100mm
Blade length: 30mm



B-49 Dissection scissors both sharp straight type

Stainless steel
Full length: 160mm ●
Blade length: 25mm



Most dissection of mice and rats can be done with this pair of scissors.

B-51 Curved slim scissors both sharp

Stainless steel
Full length: 130mm



B-52 Straight slim scissors sharp/blunt

Stainless steel
Full length: 135mm



B-54 Straight slim scissors both blunt

Stainless steel
Full length: 110mm



B-56 Thread removal scissors

Stainless steel
Full length: 115mm ●



Blade is shaped to allow the suture to be caught on the tip of cutting edge and removed.

B-59 Finishing scissors with finger rest

Stainless steel
Full length: 170mm



Use to finish trimming.

B-60-T Straight scissors both blunt with tungsten

Stainless steel
Full length: 130mm ●, 145mm ●, 165mm ●



B-61-T Curved scissors both blunt with tungsten

Stainless steel
Full length: 130mm ●, 145mm ●, 165mm ●



B-62-T Straight scissors both sharp with tungsten

Stainless steel
Full length: 130mm ●, 145mm ●, 165mm ●



B-63-T Curved scissors both sharp with tungsten

Stainless steel
Full length: 130mm ●, 145mm ●, 165mm ●



B-64-T Straight scissors sharp/blunt with tungsten

Stainless steel
Full length: 130mm ●, 145mm ●, 165mm ●



B-65-T Curved scissors sharp/blunt with tungsten

Stainless steel
Full length: 130mm ●, 145mm ●, 165mm ●



B-66-T Mayo straight scissors with tungsten

Stainless steel
Full length: 140mm, 170mm



B-67-T Mayo curved scissors with tungsten

Stainless steel
Full length: 140mm, 170mm



B-68-T Iris scissors both sharp with tungsten

Stainless steel
Full length: 110mm ●



B-69-T Curved iris scissors both sharp with tungsten

Stainless steel
Full length: 110mm ●



B-70-T Metzenbaum straight scissors with tungsten

Stainless steel
Full length: 145mm, 160mm, 185mm



B-71-T Metzenbaum curved scissors with tungsten

Stainless steel
Full length: 145mm, 160mm, 185mm



*With tungsten: A high-hardness alloy called "super steel" is applied to the blade to provide sharpness and long-lasting edge. (Forcible use may damage the blade.)

C-1 Pean hemostat forceps straight type without hook
 Stainless steel
 Full length: 145mm ●, 180mm, 185mm ●

C-2 Pean hemostat forceps curved type without hook
 Stainless steel
 Full length: 140mm, 145mm ●, 180mm

C-3 Kochel hemostat forceps straight type with hook
 Stainless steel
 Full length: 140mm, 145mm ●

C-4 Kochel hemostat forceps curved type with hook
 Stainless steel
 Full length: 140mm, 180mm, 185mm ●

C-5 Grain artery hemostat forceps serrated
 Stainless steel
 Full length: 130mm

C-6 Mosquito hemostat forceps straight type without hook
 Stainless steel
 Full length: 120mm ●

C-7 Mosquito hemostat forceps straight type with hook
 Stainless steel
 Full length: 120mm ●

C-8 Mosquito hemostat forceps curved type without hook
 Stainless steel
 Full length: 120mm ●

C-9 Mosquito hemostat forceps curved type with hook
 Stainless steel
 Full length: 120mm ●

C-10 Small pean hemostat forceps straight type without hook
 Stainless steel
 Full length: 120mm ●

C-11 Small pean hemostat forceps curved type without hook
 Stainless steel
 Full length: 120mm ●

C-12 Small kochel hemostat forceps straight type with hook
 Stainless steel
 Full length: 120mm ●

C-13 Small kochel hemostat forceps curved type with hook
 Stainless steel
 Full length: 120mm ●

C-14 Special curved hemostat forceps without hook
 Stainless steel
 Full length: 125mm
 Right side bend: 15mm

C-15 Special curved hemostat forceps without hook
 Stainless steel
 Full length: 145mm
 Left side bend: 15mm

C-16-A Mathieu needle holder
 Stainless steel
 Full length: 140mm ●, 170mm, 200mm

C-16-B Still needle holder tapered type
 Stainless steel
 Full length: 140mm ●, 170mm

C-17 Arterial clamp straight

Stainless steel, Grooved/Grooveless

- C-17-30 (Length 30mm) ●
- C-17-35 (Length 35mm) ●
- C-17-40 (Length 40mm) ●
- C-17-45 (Length 45mm) ●
- C-17-60 (Only grooved · Length 60mm) ●

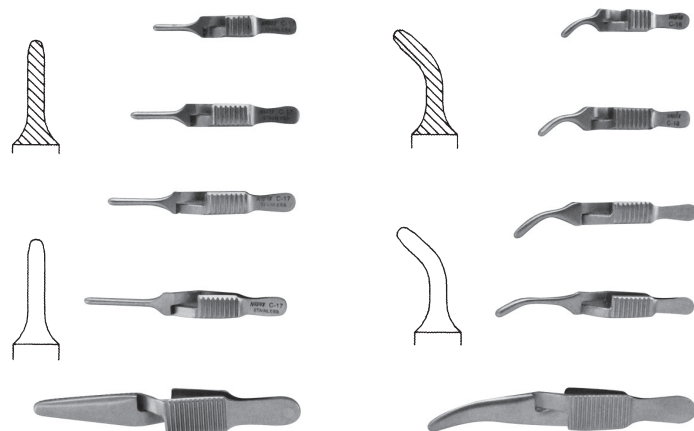

C-18 Arterial clamp curved

Stainless steel, Grooved/Grooveless

- C-18-30 (Length 30mm) ●
- C-18-35 (Length 35mm) ●
- C-18-40 (Length 40mm) ●
- C-18-45 (Length 45mm) ●
- C-18-60 (Only grooved · Length 60mm) ●

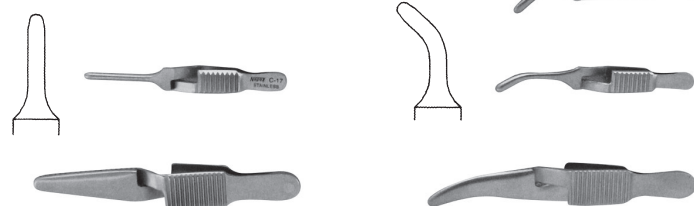

C-20 Olsen-hegar needle holder with suture cutter

Stainless steel
Full length: 145mm, 170mm



C-21 Michel suture set in plastic case

[Set contents]

C-21-2 Suture and removal forceps, 1 ea
Made of stainless steel
Length: 120mm
With open hook

Suture: Place the clamp between the grooves on both ends of the handle and squeeze the handle against the wound to close the clamp and suture it.

Removal: Insert the pointed tip between the closed clamps and squeeze the handle to open the clamps for removal.



A-2-130 Hooked tweezers straight type, 1 ea

C-21-M Michel suture clips, medium 2.5×12mm, 25 clips×4 sets

[Michel suture clip]

- C-21-S Michel suture clips, small
2.0×11mm
25 clips×4 sets
- C-21-M Michel suture clips, medium
2.5×12mm
25 clips×4 sets
- C-46 Suture clips, very small
1.75×7.5mm
25 clips×4 sets

C-27 Towel clamp

Stainless steel
Full length: 90mm

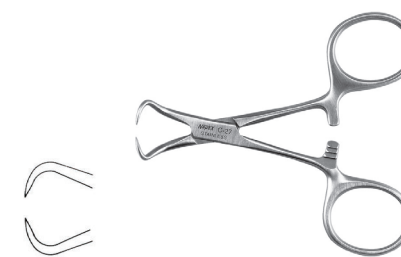

C-28 Hager needle holder

Stainless steel
Full length: 160mm ●

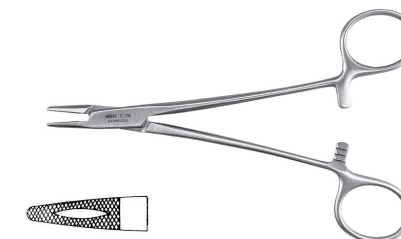

C-29-8 AUTOCLIP [applier forceps]

Stainless steel
For C-29-9 (AUTOCLIP[clips] 9mm)
Dimension: W30×L125mm
In a case

C-29-9 AUTOCLIP [clips]

Stainless steel
Dimension: W9×D4.5mm
5 rows/box (20 clips in a row)



Each suture clip is unsterilized.
Be sure to sterilize them before use.

C-29-10 AUTOCLIP [clip remover]

Dimension: 120mm
Tip: 8mm
In a case

C-30 Special kochel hemostat forceps

Stainless steel
Full length: 130mm

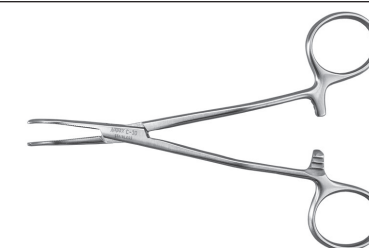

C-31 Alice forceps

Stainless steel
Full length: 150mm



C-32 Intestinal forceps straight type

Stainless steel
Full length: 215mm, 245mm

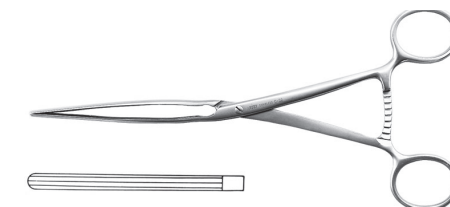

C-33 Intestinal forceps curved type
 Stainless steel
 Full length : 215mm, 245mm



C-35-T Still needle holder with tungsten
 Stainless steel
 Full length : 140mm, 170mm





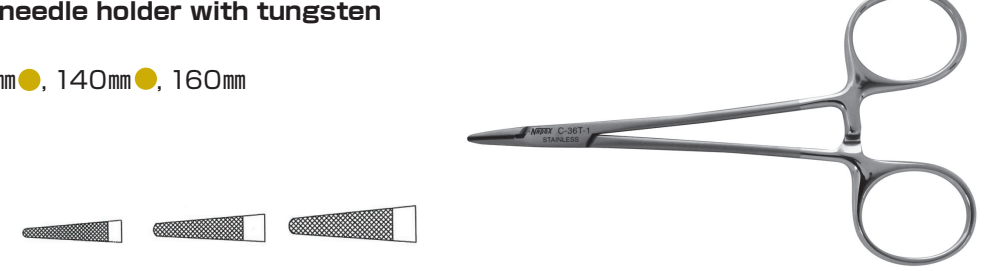

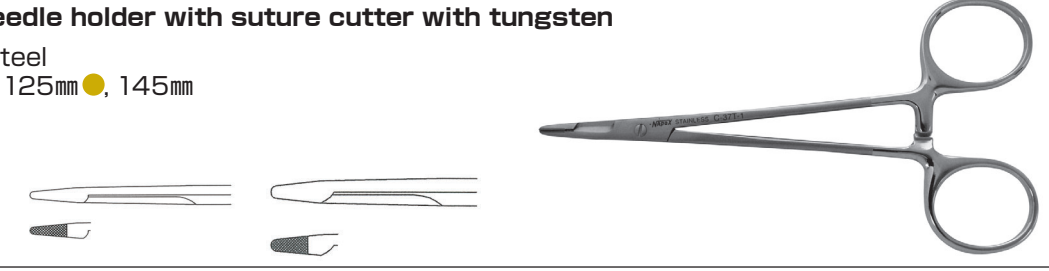

C-36-T Hager needle holder with tungsten
 Stainless steel
 Full length : 120mm ●, 140mm ●, 160mm



C-37-T Needle holder with suture cutter with tungsten
 Stainless steel
 Full length : 125mm ●, 145mm

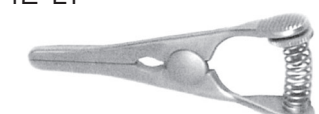

C-42 Bulldog forceps
 Stainless steel

<p>● C-42-S1 (Straight type) Dimention : 35mm ●, W0.9×L14mm</p>	C-42-S1		C-42-S2	
<p>● C-42-M1 (Straight type) Dimention : 45mm, W0.9×L18mm</p>	C-42-M1		C-42-M2	
<p>● C-42-L1 (Straight type) Dimention : 68mm, W2.4×L25mm (With spring adjustment screw)</p>	C-42-L1		C-42-L2	
<p>● C-42-S2 (Curved type) Dimention : 35mm ●, W0.9×L14mm</p>				
<p>● C-42-M2 (Curved type) Dimention : 45mm, W0.9×L17mm</p>				
<p>● C-42-L2 (Curved type) Dimention : 65mm, W2.4×L24mm (With spring adjustment screw)</p>				

C-45 Suture needle sterilization container
 Container for sterilization and storage of suture needles.
 The inner can is a porous lid type and used for sterilization and disinfection.

Material: Brass with plated finish
 Dimention : φ60×H20mm
 Porous inner can : φ55×H17mm



D-1 Scalpel round-edged(L)
 Stainless steel
 Full length : 160mm
 Blade length : 40mm

D-2 Scalpel round-edged(M)
 Stainless steel
 Full length : 150mm
 Blade length : 30mm

D-3 Scalpel round-edged(S)
 Stainless steel
 Full length : 140mm
 Blade length : 20mm



D-4 Scalpel sharp-edged(L)
 Stainless steel
 Full length : 160mm
 Blade length : 40mm

D-5 Scalpel sharp-edged(M)
 Stainless steel
 Full length : 150mm
 Blade length : 32mm

D-6 Scalpel sharp-edged(S)
 Stainless steel
 Full length : 140mm
 Blade length : 22mm



D-11 Scalpel handle

Stainless steel
 Use by attaching a disposable blade.
 Applicable replacement blade : D-13 (#10, #11, #12, #15)
 Full length : No.3 120mm ●
 No.7 160mm ●

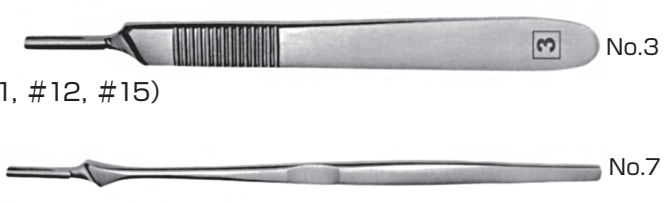

[Caution]
 Some replacement blades may not be compatible with the D-11 depending on the blade manufacturer.
 When purchasing a replacement blade, specify it as for D-11.

The replacement blades are very sharp. It is extremely dangerous to attach and remove by hands.
 Always use the D-15 or D-16 blade removal forceps to attach and remove the blade.

D-13 Spare blade scalpel No.10~15

Replacement blades for D-11
 Comes in sterilized aluminum pack.
 4 types of replacement blades available. 100 blades/box.

Some replacement blades may not be compatible with the D-11 depending on the blade manufacturer.

[Caution]
 The replacement blades are very sharp. It is extremely dangerous to attach and remove by hand. Always use the D-15 or D-16 blade removal forceps to attach and remove the blade.

When disposing, separate the blades to avoid injury from the tip of the blade, place them in a container for disposal.



D-12 Scalpel handle holder

Stainless steel
 Use by attaching a disposable blade.
 Applicable replacement blade: D-14 (#20, #21, #22, #23, #24)
 Full length: 130mm ●



[Caution]

Some replacement blades may not be compatible with the D-12 depending on the blade manufacturer. When purchasing a replacement blade, specify it as for D-12.

The replacement blades are very sharp. It is extremely dangerous to attach and remove by hand. Always use the D-15 or D-16 blade removal forceps to attach and remove the blade.

D-14 Spare blade scalpel No.20~24

Replacement blades for D-12
 Comes in sterilized aluminum pack.
 5 types of replacement blades available. 100 blades/box.
 Some replacement blades may not be compatible with the D-12 depending on the blade manufacturer.



[Caution]

The replacement blades are very sharp. It is extremely dangerous to attach and remove by hand. Always use the D-15 or D-16 blade removal forceps to attach and remove the blade. When disposing, separate the blades to avoid injury from the tip of the blade, place them in a container for disposal.

D-16 Blade removal forceps for spare blade scalpel box type

Stainless steel
 Full length: 135mm
 Tip box: W15×6mm



D-20 Oilstone

Synthetic whetstone.
 Oil whetstone for several types of blades.

- D-20-300 Oilstone#300 (Particle size#300)
 Dimension: 100×25×13mm
- D-20-3000 Oilstone#3000 (Particle size#3000)
 Dimension: 100×25×13mm

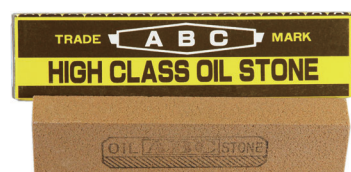

D-21 Oilstone arkansas white

Natural precision finishing oil whetstone.
 We use the highest quality natural whetstone that produced in small quantities.

*Because it is a natural stone, the internal structure may be uneven.

- D-21-S Oilstone arkansas white (Particle size#6000)
 Dimension: 75×25×6mm
- D-21-M Oilstone arkansas white (Particle size#6000)
 Dimension: 100×25×13mm



E-2 Ligature hook

Stainless steel
 Full length: 160mm



E-3 Deschamp aneurysm needle

Stainless steel
 Left bent

- E-3-L10 Inner diameter 10mm, Full length 185mm
- E-3-L20 Inner diameter 20mm, Full length 215mm
- E-3-L25 Inner diameter 25mm, Full length 230mm

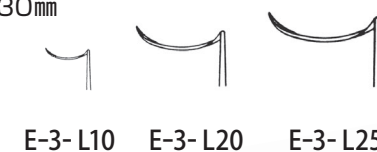

E-4 Kochel claw blunt retractors

Stainless steel
 Full length (External dimension): 220mm

- E-4-1 1nail Nail width 2mm×depth 12mm
- E-4-2 2nails Nail width 7mm×depth 12mm
- E-4-3 3nails Nail width 13mm×depth 12mm
- E-4-4 4nails Nail width 21mm×depth 12mm
- E-4-6 6nails Nail width 29mm×depth 12mm

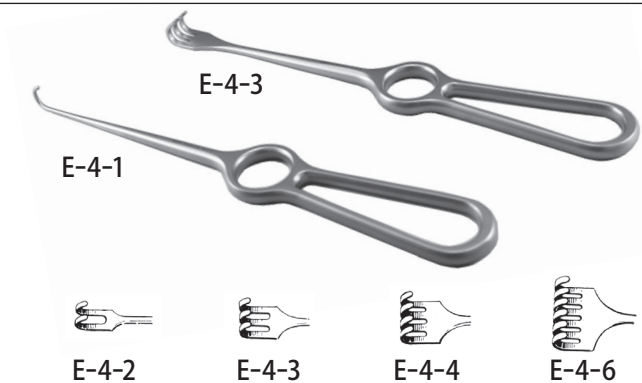

E-5 Langenbeck flat retractors

Stainless steel
 Full length: 210mm

- E-5-1 Tip width 10×D28mm
- E-5-2 Tip width 10×D40mm
- E-5-3 Tip width 14×D30mm
- E-5-4 Tip width 14×D33mm

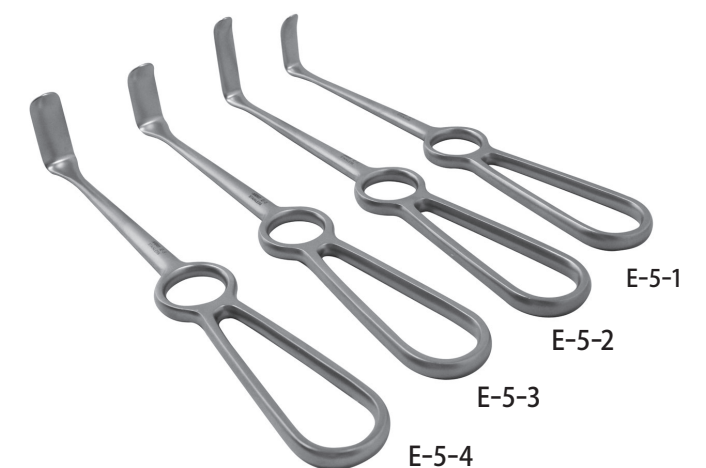

E-6 Langenbeck periosteal stripper

Full length: 200mm
 Blade width: 15mm



E-7 Plate chisel single edge

Stainless steel
 Full length : 140mm
 Blade width : 8mm, 12mm



E-8 Schade bone sharpener

Stainless steel

- E-8-00 Full length : 195mm Blade width : 4.0mm
- E-8-0 Full length : 195mm Blade width : 5.2mm
- E-8-1 Full length : 195mm Blade width : 6.0mm
- E-8-2 Full length : 195mm Blade width : 6.5mm
- E-8-3 Full length : 195mm Blade width : 6.8mm



Size No. 00 0 1 2 3

E-9 Riwel circular chisel forceps straight type

Stainless steel

- E-9-0 Full length : 190mm Cutting edge : 4×12mm
- E-9-1 Full length : 190mm Cutting edge : 6×15mm
- E-9-2 Full length : 190mm Cutting edge : 8×15mm
- E-9-3 Full length : 220mm Cutting edge : 10×15mm
- E-9-4 Full length : 220mm Cutting edge : 12×20mm



E-10 Riwel circular chisel forceps curved type

Stainless steel

- E-10-0 Full length : 190mm Cutting edge : 4×12mm
- E-10-1 Full length : 190mm Cutting edge : 6×15mm
- E-10-2 Full length : 190mm Cutting edge : 8×15mm
- E-10-3 Full length : 220mm Cutting edge : 10×15mm
- E-10-4 Full length : 220mm Cutting edge : 12×20mm



E-12-2 Dissection saw

Material : (Handle)Steel plating
 (Blade)Steel
 Full length : 180mm
 Blade width : 55mm
 Accessories : 2 replacement blades



Used for areas such as the skulls that are difficult to cut with a bone scissors.
 Replacement blades available.

E-12-3 Plate state dissection saw (Chariel)

Material : (Handle)Steel plating
 (Blade)Steel
 Blade : Steel
 Full length : 210mm, 260mm



Used to cut bones that cannot cut with bone scissors, etc.

E-12-4 Arcuate dissection saw(Chariel)

Material: Handle: Steel plating
 Blade: Steel
 Full length : 320mm
 Blade width : 210mm



E-13 KAI biopsy trephine

Full length : 95mm
 Hole diameter : ϕ 1.0, 1.5, 2.0, 2.5, 3.0, 3.5, 4.0, 5.0, 6.0, 8.0mm
 20pieces/box
 Disposable
 Sterilized



E-14-1 Pin holder with needle

Full length : 150mm (Including needle)
 With 1 needle attached



E-14-2 Stainless pin holder (no needle)

Full length : 130mm(not including needle)
 Spare needle or platinum ear can be attached.
 The glued wooden handle prevents heat from being transferred to the handle during flame sterilization.



E-14-3 Spare needle for pin holder 10 ea/pack

Full length : 45mm
 Wire diameter : ϕ 1.0
 10 ea



E-15 Bougie

Full length : 150mm, 180mm



E-16-A Surgical instrument 5 items set

In a wooden case

[Set contents]

- LB-1-145 Straight scissors both blunt 145mm 1ea.
- LB-12 Iris scissors both sharp 110mm 1ea.
- D-2 Scalpel round-edged (M) 150mm 1ea.
- A-1-130 Tweezers straight type w/o hook 130mm 1ea.
- A-5 Tapered tweezers straight type w/o hook 110mm 1ea.



E-16-B Surgical instrument 20 items set

In a wooden case

[Set contents]

- LB-1-145 Straight scissors both blunt 145mm 1ea.
- LB-3-185 Straight scissors sharp/blunt 185mm 1ea.
- LB-3-145 Straight scissors sharp/blunt 145mm 1ea.
- LB-5-145 Straight scissors both sharp 145mm 1ea.
- LB-12 Iris scissors both sharp 110mm 2ea.
- LB-23 Dissection small scissors both sharp straight type 130mm 1ea.
- LB-31-145 Dissection slim scissors straight type 145mm 1ea.
- LB-20-155 Bone scissors straight type 155mm 1ea.
- A-1-130 Tweezers straight type 130mm 1ea.
- A-3-1-130 Tapered tweezers straight type 130mm 1ea.
- A-5 Tapered tweezers straight type w/o hook 110mm 1ea.
- A-12-1 Tweezers bent tip tapered type w/o hook 110mm 1ea.
- A-20 Engineering tweezers 115mm 1ea.
- LD-12 No4 Scalpel handle 122mm 130mm 1ea.
- LC-17-40-2 Arterial clamp straight Grooved 40mm 2ea.
- LC-17-40-1 Arterial clamp straight Grooveless 40mm 3ea.



E-16-E Training surgical instrument 4 items set

In a PP case

[Set contents]

- LB-12 Iris scissors both sharp 110mm 1ea
- LB-27 Dissection small scissors sharp/blunt straight type 130mm 1ea
- A-1-130 Tweezers straight type w/o hook 130mm 1ea
- A-16 Tweezers sharp type 140mm 1ea



E-16-D Surgical instrument 38 items set

In a wooden case

[Set contents]

- LB-1-145 Straight scissors both blunt 145mm 1ea.
- LB-3-185 Straight scissors sharp/blunt 185mm 1ea.
- LB-3-145 Straight scissors sharp/blunt 145mm 1ea.
- LB-5-145 Straight scissors both sharp 145mm 1ea.
- LB-12 Iris scissors both sharp 110mm 2ea.
- LB-13 Iris scissors curved both sharp 110mm 2ea.
- LB-17 Golden crown straight scissors 120mm 1ea.
- LB-18 Golden crown curved scissors 120mm 1ea.
- LB-22 Dissection scissors 1ea.
- LB-23 Dissection small scissors both sharp straight type 130mm 1ea.
- LB-31-145 Dissection slim scissors straight type 145mm 1ea.
- A-1-130 Tweezers straight type w/o hook 130mm 1ea.
- A-5 Tapered tweezers straight type w/o hook 110mm 1ea.
- A-3-1-180 Tapered tweezers straight type 180mm 1ea.
- A-9 Tweezers bent tip tapered type w/o hook 125mm 1ea.
- A-12-1 Tweezers bent tip tapered type w/o hook 110mm 1ea.
- A-20 Engineering tweezers 115mm 1ea.
- A-26 Ring tipped tweezers ϕ 3mm 1ea.
- A-27 Ring tipped tweezers ϕ 6mm 1ea.
- A-28 Ring tipped tweezers ϕ 6x8mm 1ea.
- C-21-2 Michel suture and removal forceps 120 mm 1ea.
- C-21-S Michel suture clips, small 2.0x11mm(25 clampsx4 sets) 1ea.
- LC-6 Mosquito hemostat forceps straight type w/o hook 2ea.
- LC-10 Small pean hemostat forceps straight type w/o hook 2ea.
- LC-17-40-2 Arterial clamp straight 40mm grooved 2ea.
- LC-17-40-1 Arterial clamp straight 40mm grooveless 3ea.
- LF-2 Weiss' s retractor for detail use 1ea.
- LD-11 No3 Scalpel handle 120mm 120mm 1ea.
- LD-12 No4 Scalpel handle 122mm 130mm 1ea.
- E-12-2 Dissection saw w/ 2 replacement blades 1ea.
- B-36 Bone cutter w/ double action joint 155mm 1ea.

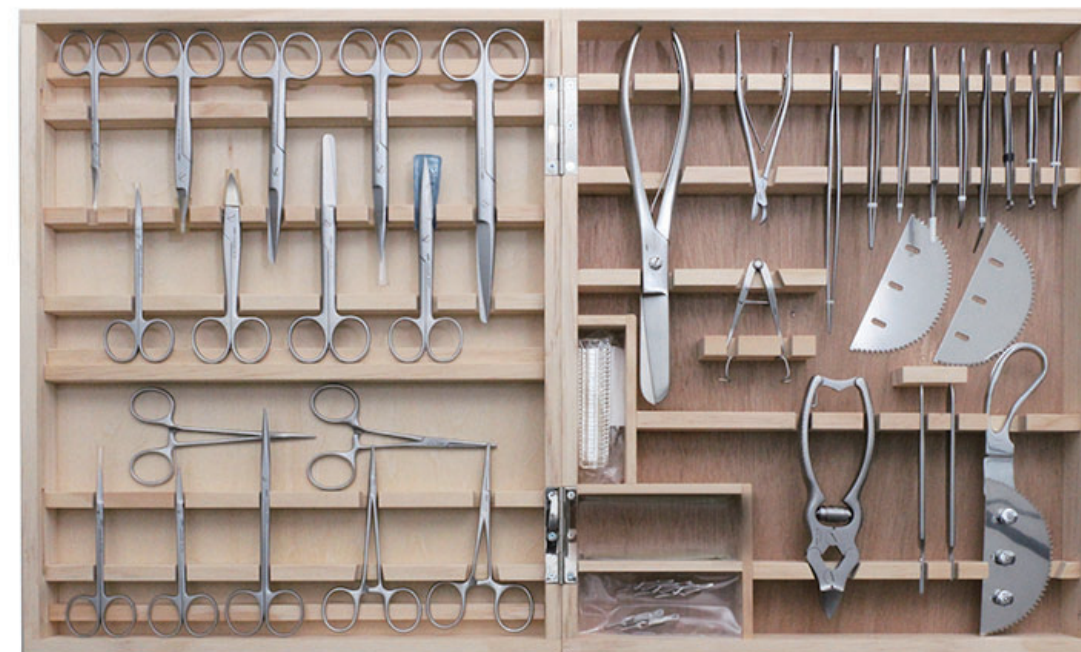

E-16-F Starter 8 instruments set with plastic case

A standard set of instruments for everything from surgery to dissection of mice and rats. Please consult with us about combinations, size changes, etc.

[Standard set]



[Set Contents]

A-1-130	Stainless steel	Tweezers straight type without hook	1 ea
		Full length: 130mm	
A-2-130	Stainless steel	Hooked tweezers straight type	1 ea
		Full length: 130mm	
A-5-110	Stainless steel	Tapered tweezers straight type without hook	2 ea
		Full length: 110mm	
LB-3-145	Stainless steel	Straight scissors sharp/blunt	1 ea
		Full length: 145mm	
LB-5-145	Stainless steel	Straight scissors both sharp	1 ea
		Full length: 145mm	
LB-12	Stainless steel	Iris scissors both sharp	1 ea
		Full length: 110mm	
LB-17	Stainless steel	Golden crown straight scissors	1 ea
		Full length: 120mm	

E-19 Syringe forceps

Stainless steel
Full length: 270mm



F-2 Weiss's retractor for detail use

Stainless steel
Full length: 80mm ●
Valve width 16 × Valve depth 8mm
Maximum opening width ~30mm

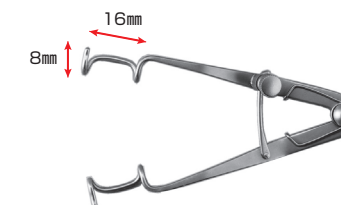

F-7 Aaddle hook retractor

Stainless steel
Full length: 140mm

- F-7-11 Width 11mm
- F-7-13 Width 13mm
- F-7-16 Width 16mm

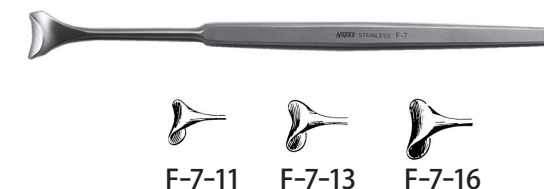

F-8 Ruthe circular chisel forceps

Stainless steel
Full length: 180mm
Upward



A Tweezers

B Scissors

C Forceps • Needle holders

D Blades

E Set

F Retractor Others

HMK Related Items

KN Laryngo scopes

MA Micro tweezers

MB Micro scissors

MC Micro others

A Tweezers

B Scissors

C Forceps • Needle holders

D Blades

E Set

F Retractor Others

HMK Related Items

KN Laryngo scopes

MA Micro tweezers

MB Micro scissors

MC Micro others

F-15 Circular chisel forceps

Stainless steel
Full length : 160mm
Cutting edge : W3×L13mm

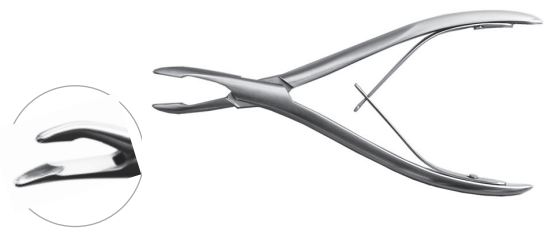

F-16 Circular chisel forceps double joint

Stainless steel
Full length : 180mm
Cutting edge : W3×L15mm



H-6 Open mouth device

Stainless steel

H-6-S Full length : 150mm
H-6-L Full length : 150mm



H-15-1 Cotton swab

Material : Brass chrome plated finish
Full length : 145mm



H-15-2 Hexagonal cotton swab (10ea/pack)

Material : Brass chrome plated finish
Full length : 145mm
Sales unit : 10 pieces/pack



H-18 Vocal cord removal forceps

Stainless steel

H-18-45 Full length : 220mm Hole diameter : 4.5mm
H-18-60 Full length : 270mm Hole diameter : 6.0mm
H-18-90 Full length : 270mm Hole diameter : 9.0mm



H-20 Wire cutter

Stainless steel
Full length : 150mm
Blade length : 20mm





KN-306-D Laryngoscope for Pigs

Specially shaped laryngoscope for pigs.
A battery inserted in the handle and the tip can be illuminated with a light bulb.

[I-Shaped Blade features]

- The I-shaped blade allows visibility from both sides, ensuring a clear view of the inside of the oral cavity.
- The spoon-shaped tip prevents the tongue from falling out.
- The light source has been positioned to allow more light to reach, increasing accuracy and making it brighter and easier to see.

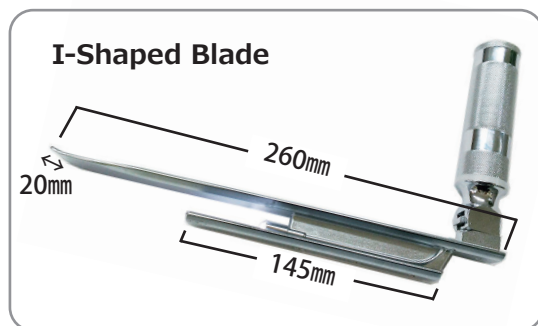

[Specifications]

Material : Brass plated finish
Full length : 260 mm (width of blade tip 20 mm)
Wing length : 145 mm

- KN-30651-LED Laryngoscope I-shaped blade for pigs and mini pigs (with LED light bulb)
- KN-30652 Handle for laryngoscope I-shaped blade (KN-30651-LED)
- KN-30651 Laryngoscope I-shaped blade for pigs and mini pigs (with regular light bulb)
- KN-306-D1 Improved Macintosh type blade Size: L280mm with light bulb
- KN-306-D2 Forager type blade Size: L300mm with light bulb
- KN-306-D3 Forager type blade Size: L200mm with light bulb
- KN-306-D4 Handle
- KN-306-D5 Light bulb

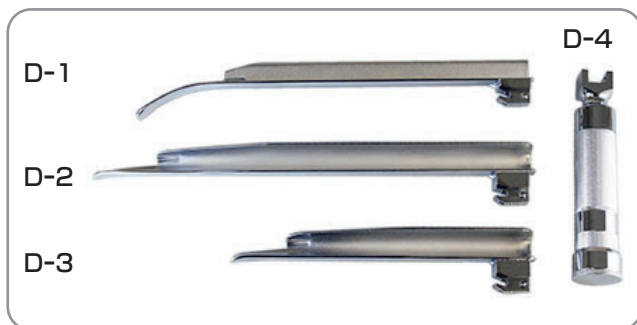

KN-1021 Laryngoscope Sets

Illuminates the tip of the laryngoscope through the fiber from the light source.
The glottis can be visualized using the light from the tip of the laryngoscope.

[Set Content]

- KN-1022 Laryngoscope for Mice 1ea
- KN-1023 Laryngoscope for Rat 1ea.
- KN-1024 LED Light source 1ea.
- KN-1025 Fiber 1ea.

Set contents can be purchased separately

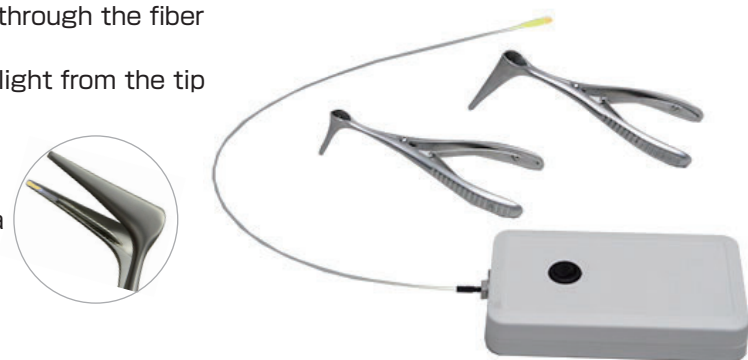

L-1 Goat cervical forceps with hook

Stainless steel
Full length : 300mm
Grip : 82mm
Lead part : 118mm
Tip part : 3mm



Guidance from Independent Administrative Institution Livestock Breeding Center Ibaraki Farm Nagano Branch

KN-353 Disposable Clips for Laboratory Animals (Not sterilized)

Clips that can be used for various purposes.
When used as a hemostatic clip, the unique shape of the part that grips blood vessels creates less pressure and does not damage blood vessels.

[Specifications]

Material : polycarbonate resin (Can be autoclaved)
Quantity : 50 clips/box

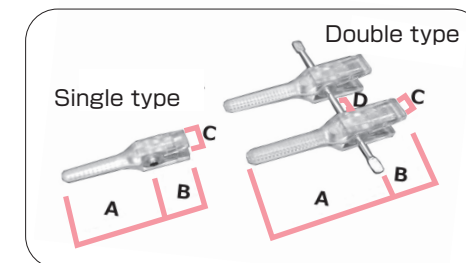

Code (KN-353)	A(mm)	B(mm)	C(mm)	D(mm)	Weight(g)	Clamping force (g/mm ²)	Blood vessel diameter
AS1-20	8.0	4.5	2.5		0.06	20	below 1mm
AS1-40						40	
AM1-30	11.5	5.5	3.0		0.12	30	1~2mm
AM1-60						60	
AL1-60	15.0	6.5	3.5		0.50	60	~4mm
AL1-120						120	
AS2-20	8.0	4.5	2.5	~7.5	0.13	20	below 1mm
AS2-40						40	
AM2-30	11.5	5.5	3.0	~7.6	0.25	30	1~2mm
AM2-60						60	
AL2-60	15.0	6.5	3.5	~7.7	0.50	60	~4mm
AL2-120						120	

*Please specify the number of grams of clamping force.

MA-41 Sharp tweezers No.1 INOX

Stainless steel
Full length : 120mm
Tip : width 0.20×thickness 0.12mm



MA-42 Sharp tweezers No.2 INOX

Stainless steel
Full length : 120mm
Tip : width 0.34×thickness 0.14mm



MA-43 Sharp tweezers No.3 INOX

Stainless steel
Full length : 120mm
Tip : width 0.08×thickness 0.04mm



MA-45 Sharp tweezers No. 5 INOX

Stainless steel
Full length : 110mm
Tip : width 0.05×thickness 0.01mm



MA-45-2 Sharp tweezers

Stainless steel
Full length : 110mm
Tip : width 0.025×thickness 0.005mm



MA-47 Curved tip sharp tweezers No.7 INOX

Stainless steel
Full length : 115mm
Tip : width 0.07×thickness 0.03mm



MA-48-1 Extra-fine tip tweezers straight type without hook
 Stainless Steel
 Full length: 95mm ●



MA-48-2 Extra-fine tip tweezers straight type without hook
 Stainless Steel
 Full length: 125mm ●

Extremely finely finished tip with no grooves.

MA-48-3 Extra-fine tip tweezers curved type with hook
 Stainless Steel
 Full length: 95mm ●



MA-48-4 Extra-fine tip tweezers curved type with hook
 Stainless Steel
 Full length: 125mm ●

Extremely finely finished tip with no grooves.

MA-49-1 Ultra-pointed tweezers straight type with hook
 Stainless Steel
 Full length: 95mm ●
 Hook: 0.7×0.55mm



MA-49-2 Ultra-pointed tweezers straight type with hook
 Stainless Steel
 Full length: 95mm
 Hook: 0.4×0.25mm ●

Extremely finely finished tip with no grooves.

MA-49-3 Ultra-pointed tweezers curved type with hook
 Stainless Steel
 Full length: 95mm
 Hook: 0.7×0.55mm ●



MA-49-4 Ultra-pointed tweezers curved type with hook
 Stainless Steel
 Full length: 95mm
 Hook: 0.4×0.25mm ●

Extremely finely finished tip with no grooves.

MA-50 45 degrees angled sharp tweezers
 Stainless Steel
 Full length: 109mm
 Tip: width 0.05×thickness 0.01mm



Tip is angled 45 degrees.

MA-51 90 degrees angled sharp tweezers
 Stainless Steel
 Full length: 106mm
 Tip: width 0.05×thickness 0.01mm



Tip is angled 90 degrees.

MA-55 Sharp tweezers with clamp ring
 Stainless Steel
 Full length: 110mm
 Tip: width 0.1×thickness 0.06mm

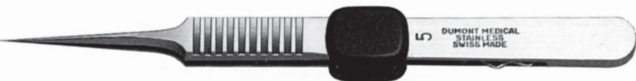

The tip can be locked in the gripped position by the resin ring attached to the body.

MA-56 Sharp tweezers with clamp ring
 Stainless Steel
 Inclined tip
 Full length: 115mm
 Tip: width 0.13×thickness 0.08mm

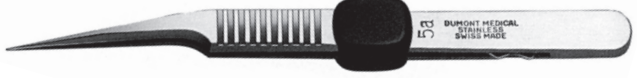

The tip can be locked in the gripped position by the resin ring attached to the body.

MA-60 Micro tweezers without hook (Colibri Type)
 Stainless Steel
 Full length: 75mm ●



MA-61 Micro tweezers with hook (Colibri Type)
 Stainless Steel

- MA-61-1 Full length: 75mm ●
Tip: width 0.25×thickness 0.25mm
- MA-61-2 Full length: 75mm ●
Tip: width 0.25×thickness 0.4mm

MA-62 Micro tweezers curved type without hook (Colibri Type)
 Stainless Steel
 Full length: 75mm ●



MA-63 Micro tweezers curved type with hook (Colibri Type)
 Stainless Steel
 Full length: 75mm ●
 Tip: width 0.25×thickness 0.25mm



MA-65 Micro tweezers curved type without hook (Person Type)
 Stainless Steel
 Full length: 95mm ●



MA-66 Micro tweezers curved type with hook (Person Type)
 Stainless Steel
 Full length: 95mm ●



MA-68 Adson type tweezers without hook
 Stainless Steel
 Full length: 120mm ●
 Tip: width 0.5×thickness 1mm



MA-69 Adson type tweezers with hook
 Stainless Steel
 Full length: 120mm ●
 Tip: width 0.5×thickness 1mm



MB-41 Micro scissors weckel

Stainless Steel
Full length: 110mm
Blade length: 10mm ●



MB-50-7 Micro scissors straight type

Stainless Steel
Full length: 105mm ●
Blade length: 7mm



MB-50-10 Micro scissors straight type

Stainless Steel
Full length: 110mm ●
Blade length: 10mm

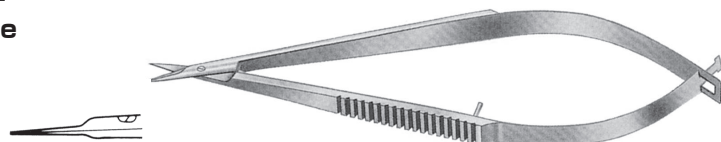

MB-50-15 Micro scissors straight type

Stainless Steel
Full length: 115mm ●
Blade length: 15mm

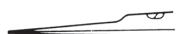

MB-51-7 Micro scissors curved type

Stainless Steel
Full length: 108mm ●
Blade length: 7mm



LMB-51-10 Micro scissors curved type

Stainless Steel
Full length: 110mm ●
Blade length: 10mm



LMB-51-15 Micro scissors curved type

Stainless Steel
Full length: 115mm ●
Blade length: 15mm



MB-52-1 Micro scissors straight type special sharp/blunt

Stainless Steel
Full length: 110mm ●
Blade length: 8mm



MB-52-2 Micro scissors straight type special sharp/blunt

Stainless Steel
Full length: 115mm ●
Blade length: 10mm



The left and right blade lengths are different

MB-53 Micro scissors angled upward

Stainless Steel
Full length: 110mm
Blade length: 8mm ●



MB-54-1 Micro scissors straight type

Stainless Steel
Full length: 85mm ●
Blade length: 5mm



MB-54-2 Micro scissors curved type

Stainless Steel
Full length: 85mm ●
Blade length: 5mm



MB-54-3 Micro scissors angled upward

Stainless Steel
Full length: 85mm ●
Blade length: 5mm



MB-55 Micro scissors angled sideways

Stainless Steel
Full length: 105mm ●
Blade length: 8mm



MB-56 Micro scissors straight type

Stainless Steel
Full length: 165mm ●
Blade length: 10mm



MB-57 Micro scissors curved type

Stainless Steel
Full length: 165mm ●
Blade length: 10mm



MC-35 Micro needle holder straight type
 Stainless steel
 Full length: 105mm ●



MC-36 Micro needle holder curved type
 Stainless steel
 Full length: 108mm ●



MC-37 Micro needle holder straight type
 Stainless steel
 Full length: 155mm ●

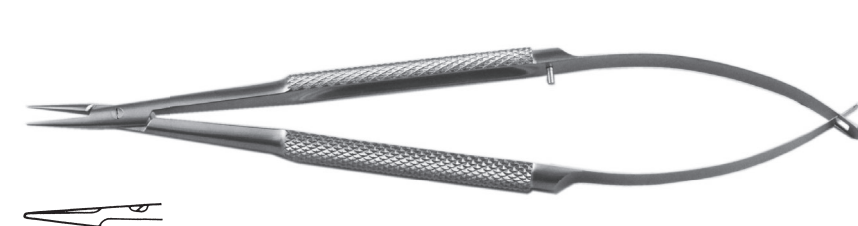

MC-38 Micro needle holder curved type
 Stainless steel
 Full length: 155mm ●



MC-40 Micro needle holder straight type
 Stainless steel
 Full length: 120mm ●

MC-41 Micro needle holder curved type
 Stainless steel
 Full length: 120mm ●



MC-45 Micro needle holder straight type with hook
 Stainless steel
 Full length: 123mm ●



MC-46 Micro needle holder curved type with hook
 Stainless steel
 Full length: 123mm ●



MD-16 Razor blade holder
 Stainless steel
 Full length: 120mm



ME-1 Micro forceps straight type
 Stainless steel
 Full length: 120mm ●



ME-2 Micro forceps curved type
 Stainless steel
 Full length: 120mm ●

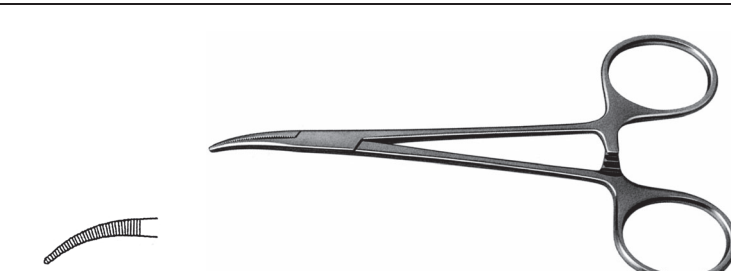

MF-1 Barakke eye speculum
 Stainless steel

	a	b
MF-1-1	27×	5mm
MF-1-2	34×	9mm
MF-1-3	42×	12mm
MF-1-4	42×	14mm

